

This is a programmable room thermostat. It works by sensing the air temperature, switching on the heating when the air temperature falls below the thermostat setting, and switching it off once this set temperature has been reached. It allows users to select different temperatures in your home at different times of the day to meet particular user's needs and preferences. But thermostat to a higher temperature will not make the room heat up any faster. How quickly the room heats up depends on the design and size of the heating system. Similarly reducing the temperature setting does not affect how quickly the room cools down.



## Functions

---

- Attractive Black LCD Display
- White Backlight
- Adjustable Eco Mode, Manual Mode and PRG. mode control
- Water heating system
- 7 days Programmable (4 periods/day)
- Room or SET temperature display
- Open Window Detection
- Keylock Function
- Frost protection
- CE, RoHs, RED

## Technical Data

---

|                   |               |                  |  |
|-------------------|---------------|------------------|--|
| Power Supply      | 230V, 50/60Hz | Backlight        | White                                  |
| Max Load          | 16A or 3A     | Sensor           | NTC 10K                                |
| Set Point Range   | 5~35°C        | Accuracy         | ±0.5 °C (step control by +0.5°C)       |
| Ambient           | 0~50°C        | Protection Class | IP30                                   |
| Relative Humidity | 85%           | Housing          | - ABS to UL94-5 fire retardant plastic |

## Display & Buttons

---

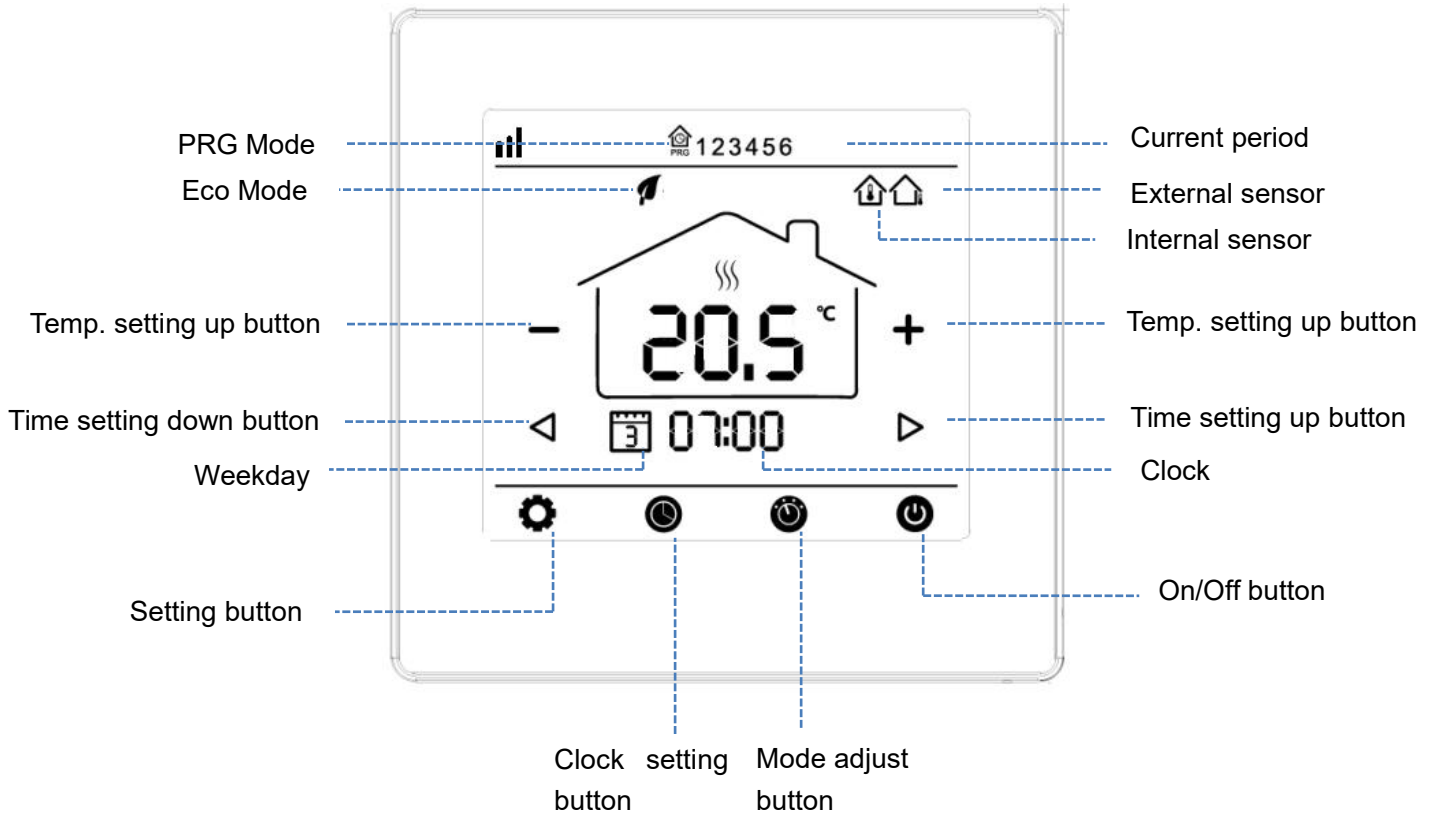



## WIFI Connection (Optional)

---

1. On the app store or google play, search for “ Smart life” or scan below QR code to download.  
If you are downloading the app for the first time, please tap “ Register” to register an account. If you have account, please click “ Login” Button.





2. Make sure that mobile phone is connect to the home 2.4Ghz band router, at this time, the thermostat and the mobile phone at the same home router network
3. Open the “My Home” page of the app, and click the “ +” button at upper right corner of the screen.
4. Select “Home Applicants II”
5. Find “ Thermostat” on the list and click
6. On thermostat, Long press  button to enter wifi connection mode, then press  button , the wifi icon  will flash

7. Press “Confirm indicator rapidly blink” on phone, and enter WIFI password. When pair success, the wifi icon will stop flash, and the digit at thermostat change from 0 to 1.

8. Wait a moment till connection done. Now you are start operation.

## Child Lock





Refer to the Menu 12 of Parameter setting to lock it.

Press  and  button at the same time to unlock it for temporary adjust.







## Model Select

Press  button to choose Comfort mode/Economy mode/PRG mode.

## Clock & Weekday Setting

Press and hold  button for 3s, set the clock (Min-Hour-Weekday) by pressing  and  button, each press of  button will go to next item setting. Press  to save and exit.

## Weekly Programmable Setting

Press and hold  for 3s to enter PRG schedule setting. By pressing “” and “” to, you can set each period start time “” and “” to set desired setpoint. Each press of  will go to next item setting. Press  to save and exit.

**Default Setting:**

| Period   | 1    |       | 2    |      | 3     |      | 4     |      |
|----------|------|-------|------|------|-------|------|-------|------|
|          | Time | Temp. | Time | Temp | Time  | Temp | Time  | Temp |
| 1 (Mon.) | 7:00 | 22°C  | 8:30 | 19°C | 17:00 | 22°C | 22:00 | 19°C |
| 6(Sat.)  | 8:00 | 22°C  | 8:30 | 22°C | 17:00 | 22°C | 23:00 | 19°C |
| 7(Sun.)  | 8:00 | 22°C  | 8:30 | 22°C | 17:00 | 22°C | 23:00 | 19°C |

## Optional Settings Explained

**Feature 01**– This feature used to calibrate the air sensor temperature when need.

**Feature 02/03**– Temperature Max.& Min. Limit: This function allows you to limit the use of the up and down temperature arrow keys.

**Feature 04**– Sensor Selection: On this thermostat, you can select which sensor should be used. You can select between air temperature only, floor temperature, or both. When you enable both sensors, the floor sensor is used as a floor limiting sensor and is designed to prevent the floor from overheating.

**Feature 05** - Frost Protect Temperature: This is the temperature maintained when the thermostat is in Frost Mode. The range is 05 - 15°C. The default is 5°C.



**Feature 06**– This feature used to calibrate the floor sensor temperature when need.

**Feature 07**– When feature 04 select to used both air sensor & floor sensor, here you can read the floor temperature.

**Feature 08** – Floor Temp(Overheat) Limit: This function is available when feature 04 is set to 02. You can set a floor limiting temperature between 10-35°C (32°C is the default setting).

Note: Air Sensor only MUST NOT be used to control electric under-floor heating. Floor Sensor or Both should be used.

**Feature 09** - Switching Differential: This function allows you to increase the switching differential of the thermostat. The default is 0°C which means that with a set temperature of 20°C, the thermostat will switch the heating on at 19.5°C and off at 20.5°C. With a 0.5°C differential, the heating will switch on at 19°C and off at 21°C.

**Feature 11**– This feature used to lock the keys. When lock, press  and  button at the same time to unlock it.

**Feature 12**-This function allows you to save energy. When enable Open Window Detection function, the system will automatically stop heating when it detects a sudden drop of room temperature (2°C in 15 minutes as default). This is normally caused when a window or door is opened without turning off the heating device.





The device will return to the previous mode of operation after 30mins, then icon  disappear. Press any button will exit OWD function during the heating off period.

**Feature 13**-The setting time to detect the drop of room temperature between 2-15mins (15 mins is the default setting).

**Feature 14**-The drop temperature to during detect period. Setting between 2-4°C (2°C is the default setting).

**Feature 15**-The time to exit OWD mode select. Setting between 10~60min(30min is the default setting).

## Feature Table

Turn thermostat off, press and hold the hidden  for 5s to enter parameter setting. Each press of  button will go to next item setting. Change the setting by using  and . Press  to save and exit.

| Feature | Description                  | Range       | Default Value |
|---------|------------------------------|-------------|---------------|
| 01      | Internal Sensor Temp. Offset | -8 °C ~8 °C | 0             |
| 02      | Set Point Max.               | 5 °C ~35°C  | 35 °C         |

|    |   |                   |             |
|----|---|-------------------|-------------|
| 03 | Set Point Min.  | 5 °C ~35°C        | 5 °C        |
| 04 | Sensor Select   | 0: Air            | Air & Floor |
|    |   | 1: Floor          |             |
|    |   | 2: Air & Floor    |             |
| 05 | Frost Protection Temp.  | 5 °C ~15°C        | 5 °C        |
| 06 | External Sensor Temp. Offset                                      | -8 °C ~8 °C       | 0           |
| 07 | Floor Temp. Display   | Read Only         |             |
| 08 | Floor Temp(Overheat) Limit  | 10 °C ~35°C       | 32 °C       |
| 09 | Deadband/Switching Differential                                   | 0 °C ~3°C         | 0 °C        |
| 11 | Child Lock  | 1: Lock 0: Unlock | 0           |
| 12 | OWD function  | 1: ON 0: OFF      | OFF         |
| 13 | OWD Detect Time   | 2~30mins          | 15mins      |
| 14 | OWD Drop temp. select<br>( within detect time )                   | 2-4°C             | 2 °C        |
| 15 | OWD Mode Exit time select.<br>(Return to previous working status) | 10~60min          | 30mins      |
| 17 | Reset   | rE(Yes)           |             |
|    | Software version  |                   |             |

Notes: Feature 06, 07,08 will display only when feature 04 select both air and floor sensor.

## Wiring Diagram

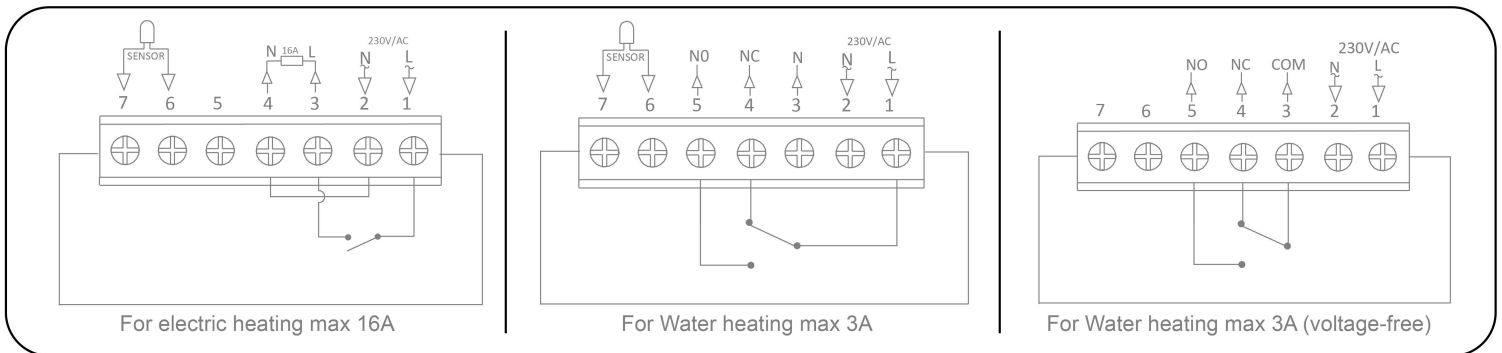

## Installation Procedure



### DO

- Mount the thermostat at eye level.
- Read the instructions fully so you get the best from our product.



### DON'T

- Do not install near to a direct heat source as this will affect functionality.
- Do not push hard on the LCD screen as this may cause irreparable damage.

**The thermostat is designed to be flush mounted and requires a back box of 35mm (minimum depth) to be sunk into the wall prior to installation.**

## Step 1

Using a small screwdriver, slightly loosen the screw from the bottom face of the thermostat. Then carefully separate the front half from the back plate.

## Step 2

Place the thermostat front somewhere safe. Terminate the thermostat as shown in the diagram

## Step 3

Screw the thermostat back plate securely into the back box.

## Step 4

Clip the front of the thermostat onto the back plate

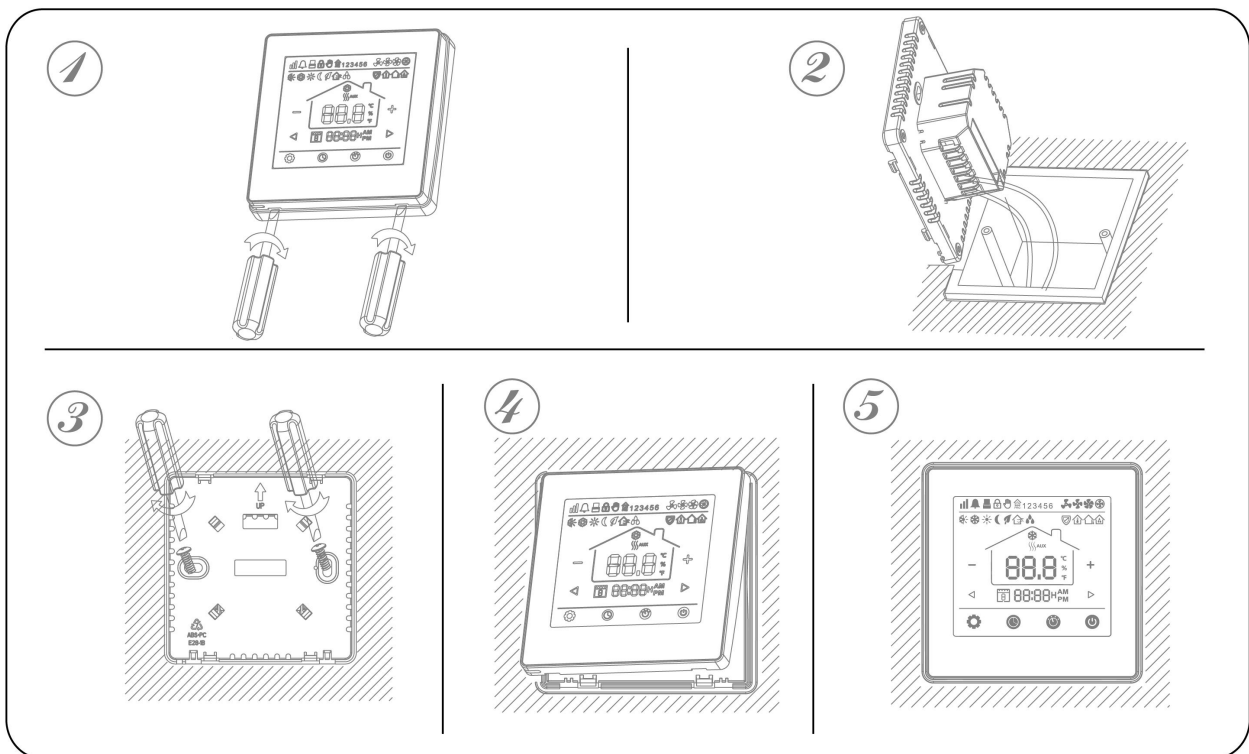

## Size

